



Gen-5X Series Fighting Board

YOUR GAME.
OUR PLAY.

Gen-5X Series Fighting Board

Support USB Interface :

- Sony Playstation 5
- Xbox Series X/S
- Nintendo Switch
- PC



Breek

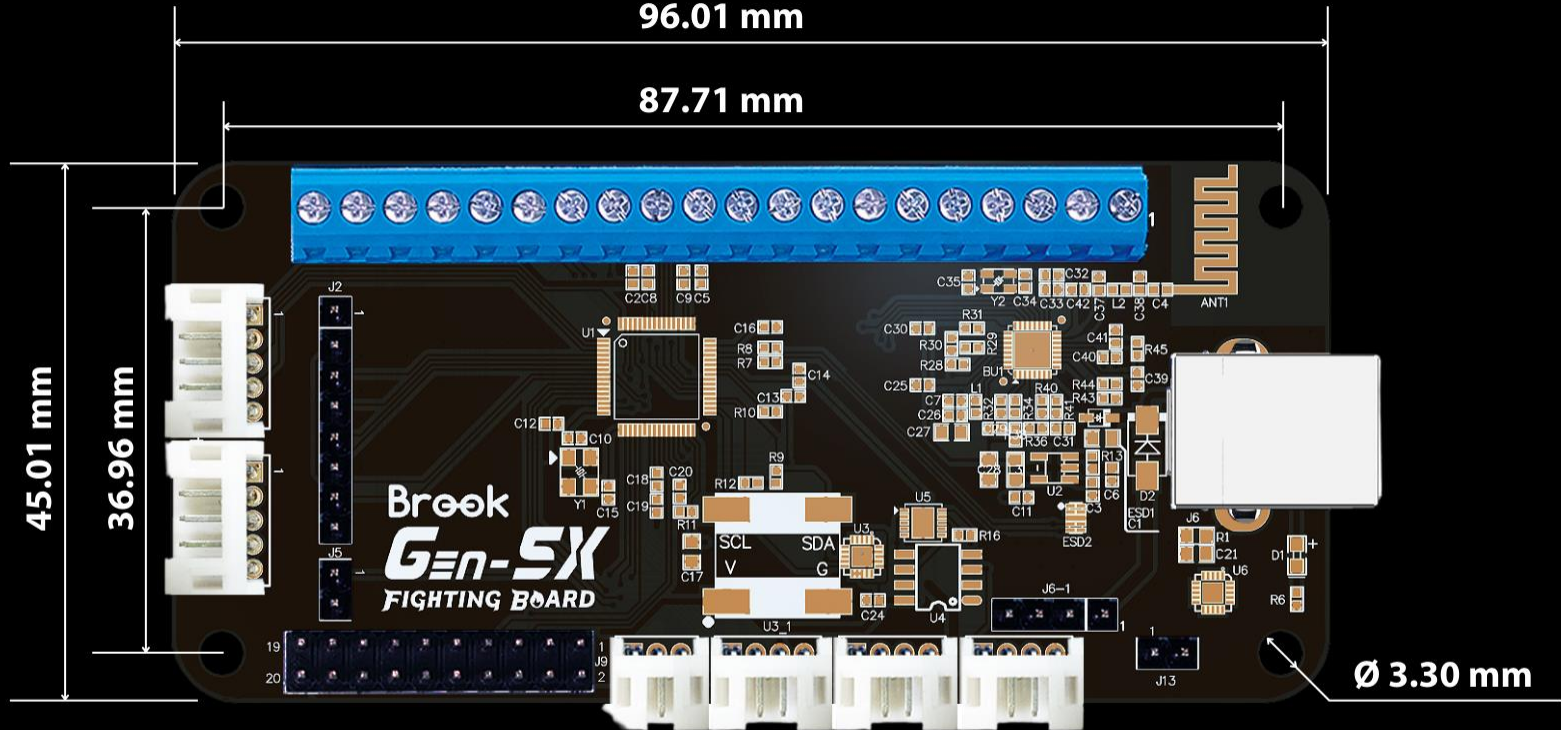

PCB TOP

SIZE : 45.01 X 96.01 mm

HOW TO CONNECT J3 DETAIL

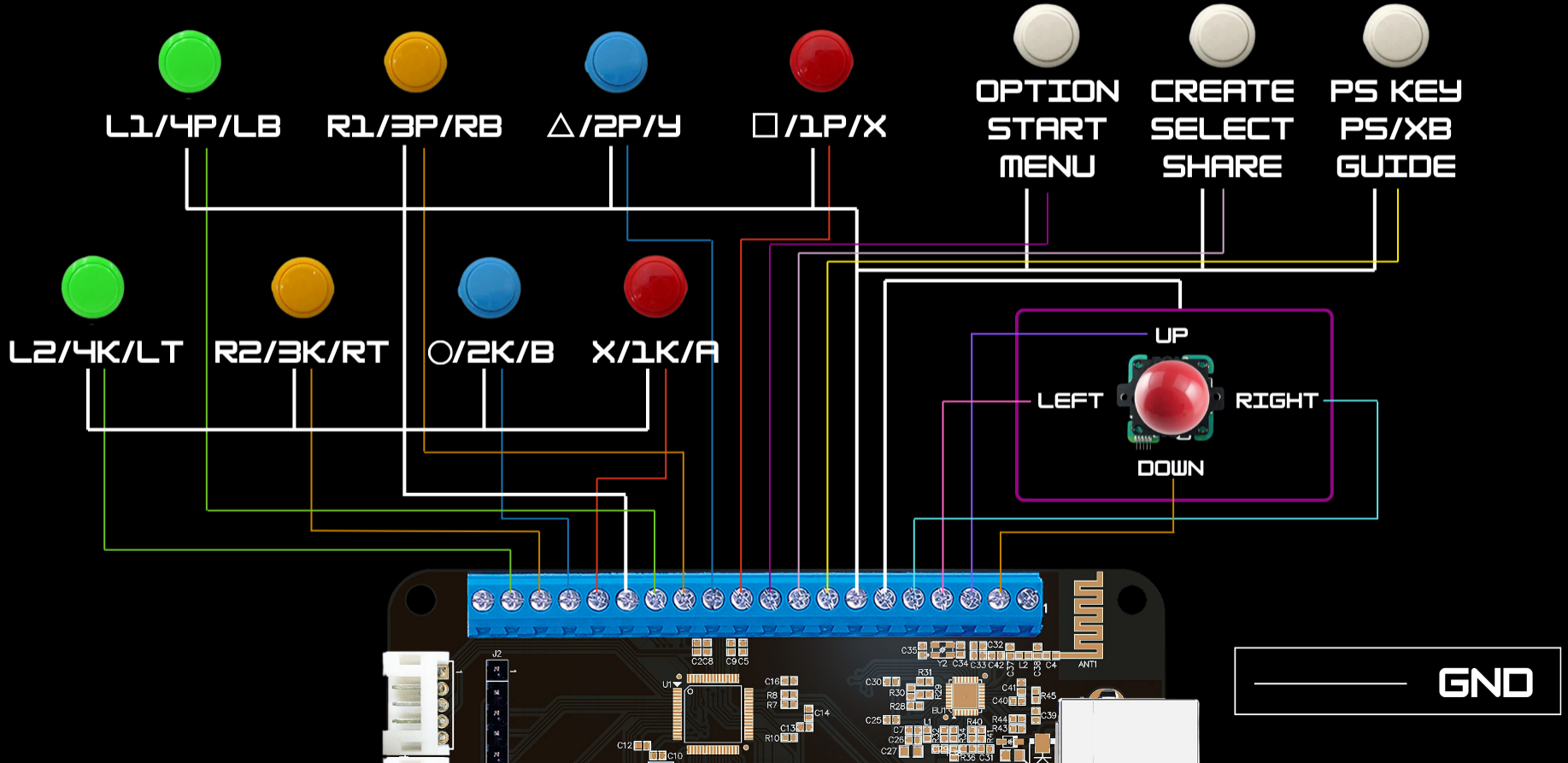

HOW TO CONNECT J9 PIN NAME

VCC(5V)	VCC(5V)
GND	GND
L2/4K/LT	R2/3K/RT
○/2K/B	X/1K/A
GND	L1/4P/LB
R1/3P/RB	△/2P/Y
□/1P/X	OPTION / START / MENU
PS KEY / PS/XB /GUIDE	CREATE / SELECT / SHARE
LEFT	RIGHT
DOWN	UP

HOW TO CONNECT J7 & J10 DETAIL

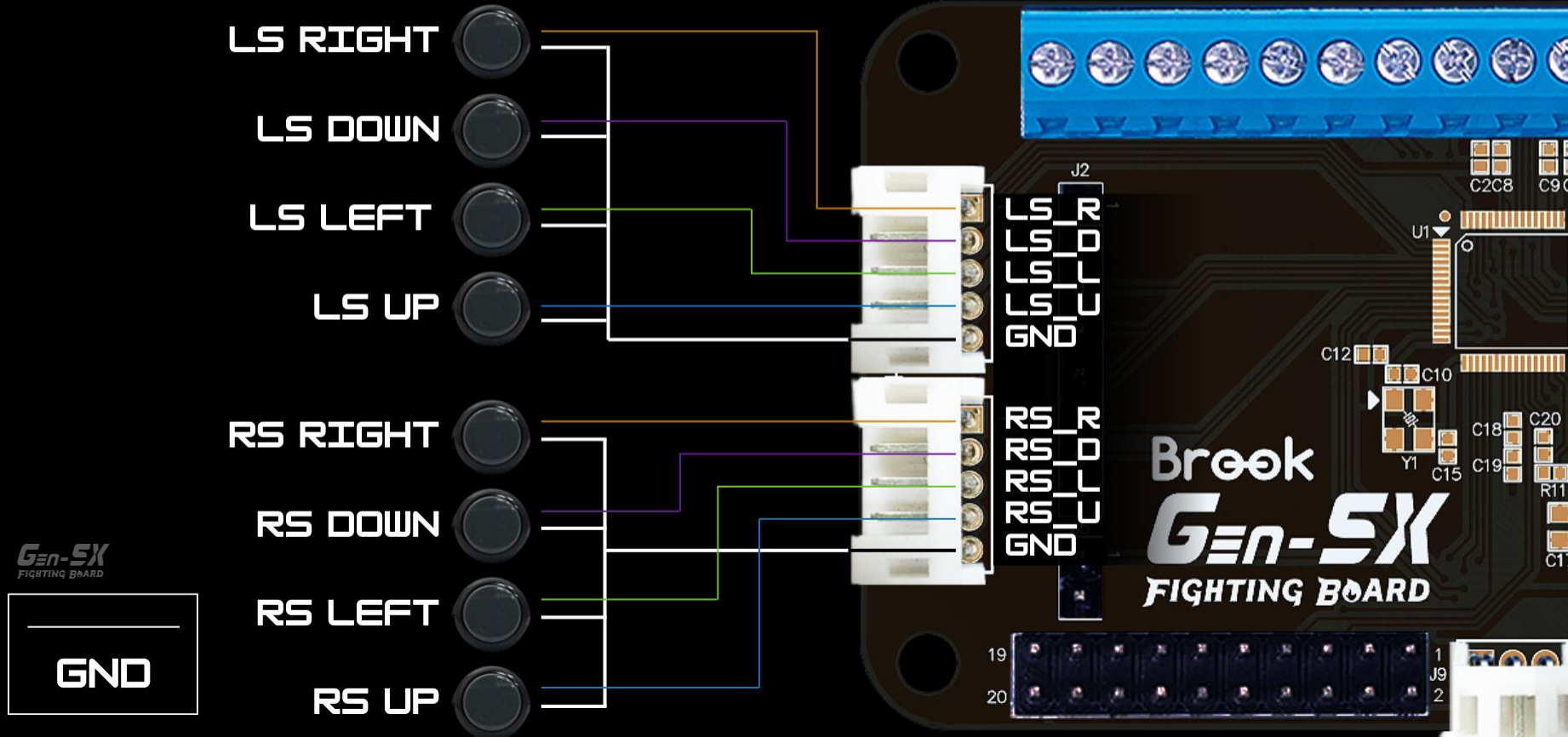

HOW TO CONNECT J2 & J5 DETAIL

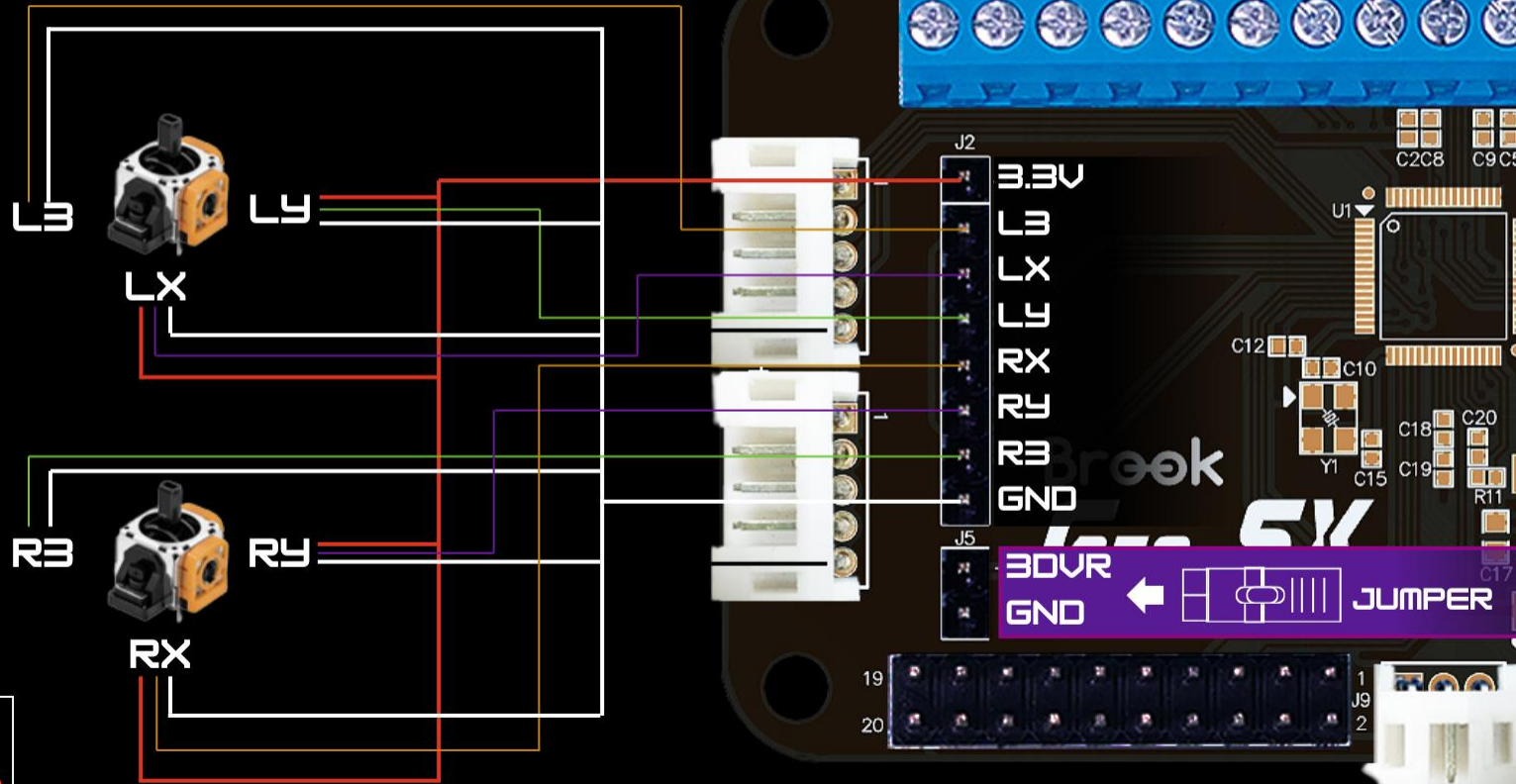

Gen-5X
FIGHTING BOARD

GND

POWER(3.3V)

Brook Gen-SX FIGHTING BOARD

HOW TO CONNECT J4 & J8 DETAIL

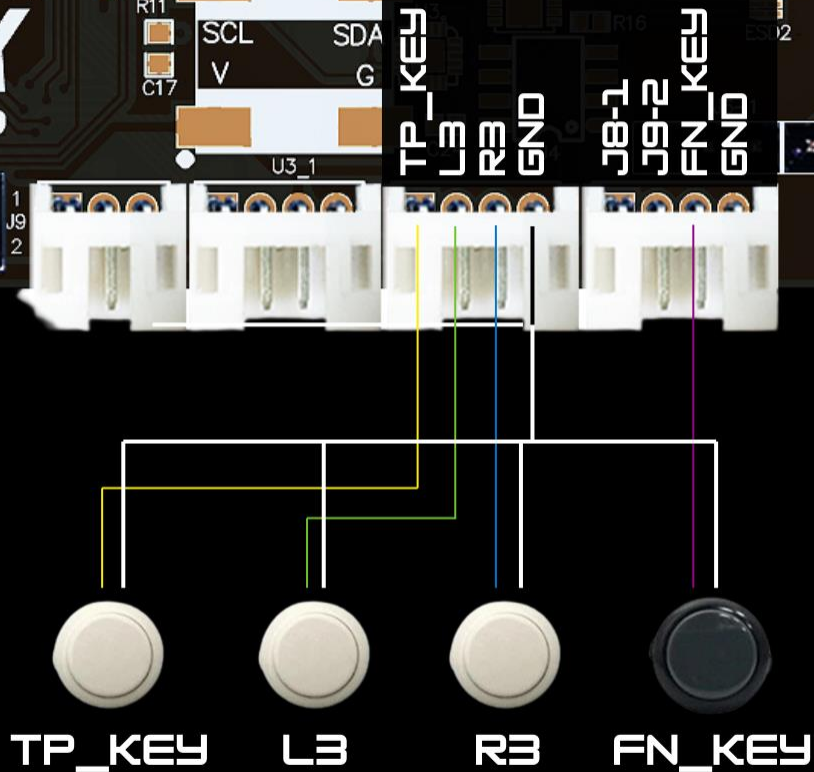

*To use Turbo, RGB LED adjustment, and other settings with hotkey operations, it is necessary to connect an external FN key.

GND

HOW TO CONNECT USB CONNECTOR (J6-1) DETAIL

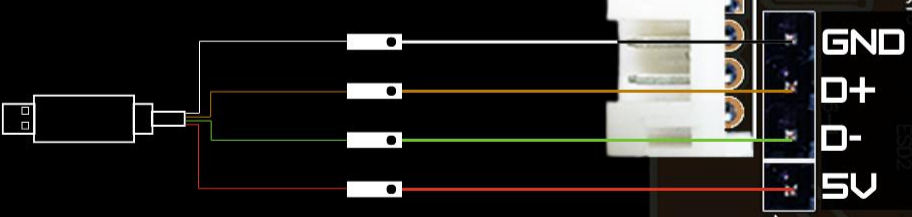

Gen-SX
FIGHTING BOARD

GND

POWER(5V)

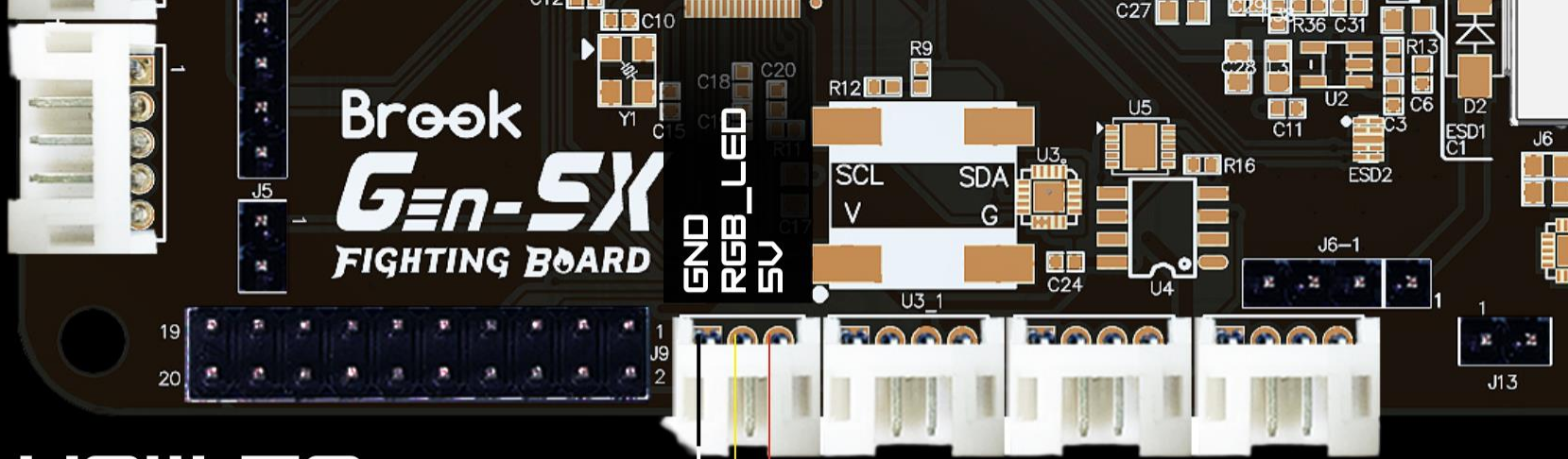

HOW TO CONNECT **J11** DETAIL

*The order in which the RGB lights on the buttons illuminate will follow the wiring sequence. For example, the first connection will be numbered as 1, and so on.

*Compatible with WS2812B RGB LEDs and requires a daisy-chaining connection

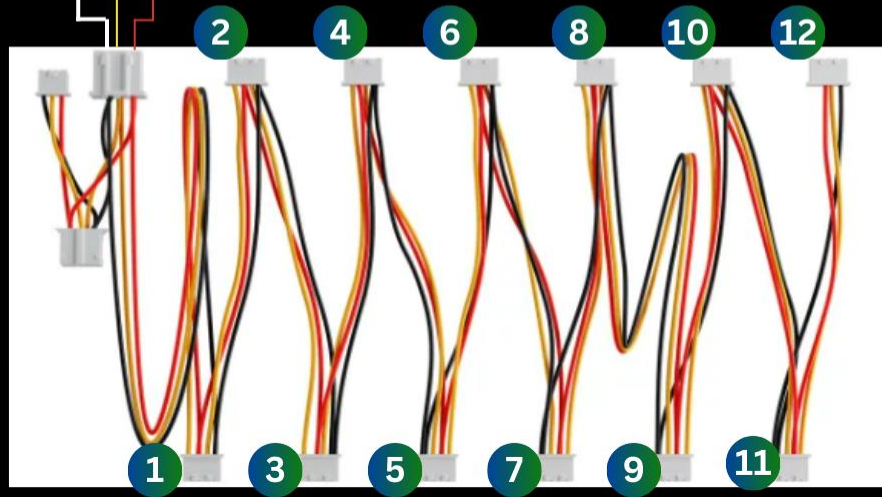

Brook Gen-SX FIGHTING BOARD

HOW TO CONNECT J12 DETAIL

— GND

— POWER(3.3V)

General SPEC

VCC : 3.3v~5v

SCL : Clock Line

SDA : Data Line

Resolution : 128 x 64

Driver IC : SSD 1309, compatible
with SSD1306

Interface : I2C Interface

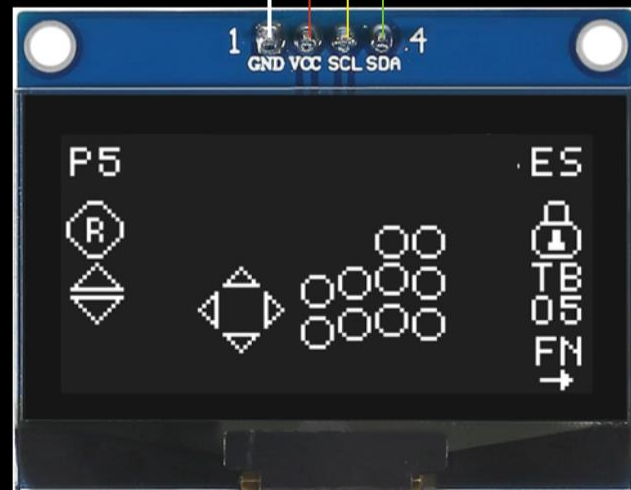

**YOUR GAME.
OUR PLAY.**

Gen-SX
FIGHTING BOARD

Gen-SX^{mini}
FIGHTING BOARD

Function Operation and Configuration Guide.



Breek

YOUR GAME.
OUR PLAY.



Gen-5X Series Fighting Board

Button Mapping

PCB Define	Sony Playstation 5	Xbox Series X/S	Nintendo Switch
Dpad-U	Dpad-U	Dpad-U	Dpad-U
Dpad-D	Dpad-D	Dpad-D	Dpad-D
Dpad-R	Dpad-R	Dpad-R	Dpad-R
Dpad-L	Dpad-L	Dpad-L	Dpad-L
Square	□	X	Y
Triangle	△	Y	X
R1	R1	RB	R
L1	L1	LB	L
Cross	×	A	B
Circle	○	B	A
R2	R2	RT	ZR
L2	L2	LT	ZL
L3	L3	LTSB	LSB
R3	R3	RTSB	RSB
TP_Key	Touch Key	View	Minus
Option	Option	Menu	Plus
PS_Key	PS key	Guide	Home
Share	Create	Share	Capture
LS_U	LStick-U	LStick-U	LStick-U
LS_D	LStick-D	LStick-D	LStick-D
LS_L	LStick-L	LStick-L	LStick-L
LS_R	LStick-R	LStick-R	LStick-R
RS_U	RStick-U	RStick-U	RStick-U
RS_D	RStick-D	RStick-D	RStick-D
RS_L	RStick-L	RStick-L	RStick-L
RS_R	RStick-R	RStick-R	RStick-R

YOUR GAME.
OUR PLAY.



Breek

Gen-5X Series Fighting Board

1. Supports Switch controller interface mode
2. Supports four SOCD modes
3. Support stick mapping to LS/DP/RS
4. Support Turbo function
5. Supports Touchpad emulation
6. Supports RGB LED
7. Supports Lock function
8. Supports OLED

Supports Switch controller interface mode

- **Manual Switching** : To manually select a mode, follow these steps

1. Press and hold the desired switch button.
2. Reinsert the device or press the Reset button.

*It will remember the last selected settings.

Switch buttons for each mode :

- 1P(Square) : Sony Playstation 5
- 2P(Triangle) : Xbox Series X/S
- 3P(R1) : Nintendo Switch
- 4P(L1) : PC (XID mode)

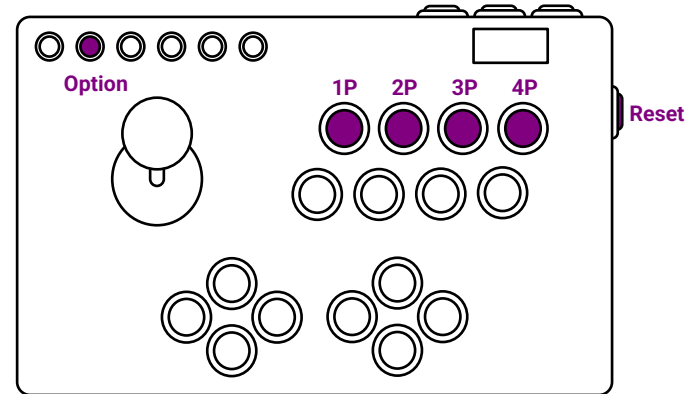

Supports four SOCD modes

- The default setting is Mode 1.
- When you change the SOCD mode, it will be saved automatically.
- Here's how to switch SOCD modes :

	Mode1 Up Priority	Mode2 All Neutral	Mode3 Last Priority	Mode4 ByPass
Mode Switching Instructions	Hold the left button and insert the device or press the Reset button.	Hold the up button and insert the device or press the Reset button.	Hold the down button and insert the device or press the Reset button.	Hold the right button and insert the device or press the Reset button.
←+→	Neutral	Neutral	→	←+→
→+←	Neutral	Neutral	←	→+←
↑+↓	↑	Neutral	↓	↑+↓
↓+↑	↑	Neutral	↑	↓+↑

Support stick mapping to LS/DP/RS

- Press and hold the following button combinations for about three seconds to switch between DP/RS/LS modes :

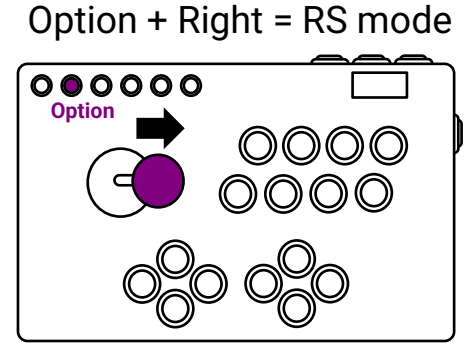
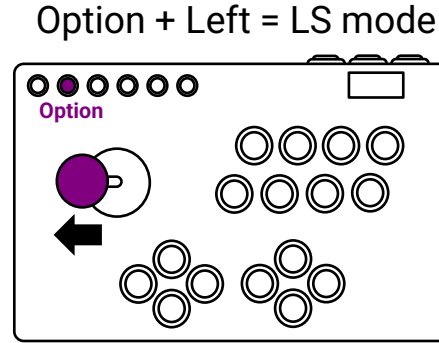
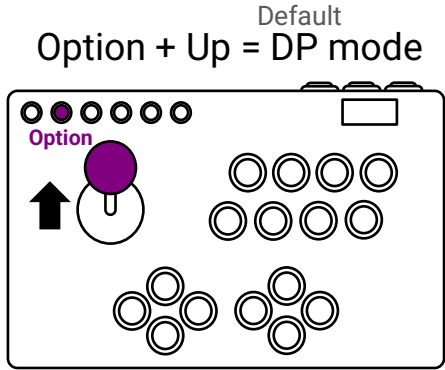

Support Turbo function

- There are currently five key press frequencies available : 5, 10, 15, 20, and 25 Hits/Sec.
- Hold 【Fn+Option】 , then press ↑ to increase the frequency; press ↓ to decrease the frequency.
- Hold 【 Fn+ Option 】 , then press the button you want to set or cancel the turbo function
- The keys that can be set for the Turbo function are : Square 、 Triangle 、 Cross 、 Circle 、 R1 、 L1 、 R2 、 L2 、 R3 、 L3

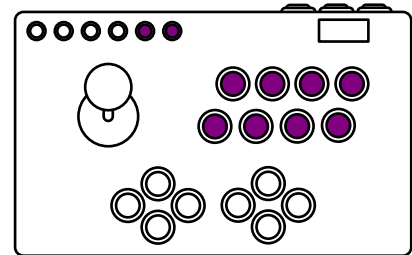

Support Touchpad emulation

- Press and hold the following button combinations to simulate the corresponding touchpad operations :

TP Key + Left = Left touchpad

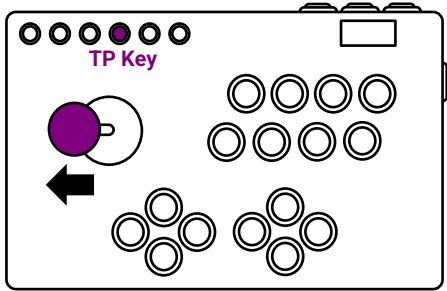

TP Key = Middle touchpad

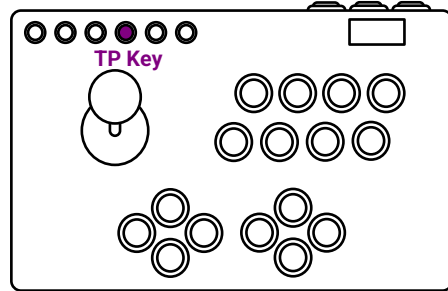

TP Key + Right = Right touchpad

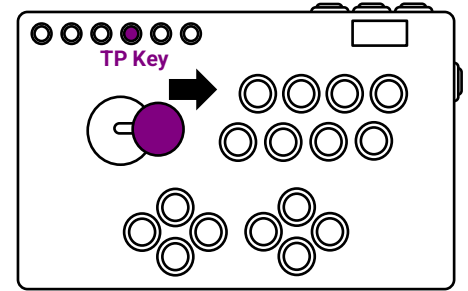

YOUR GAME.
OUR PLAY.



Gen-5X Series Fighting Board

Supports RGB LED

- Compatible with WS2812B RGB LEDs and requires a daisy-chaining connection.
- Upon power-up, the RGB LEDs will light up each button in sequence in a marquee style. The lighting sequence will follow the order of the daisy-chained RGB LEDs.

Supports RGB LED

- RGB LED operation and instructions :

1. Fn + 1P : Switch lighting effects.

Effect sequence : All off (default) → Turn off when pressed → Turn on when pressed → Breathing light → Marquee (left to right) → Marquee (right to left)

2. Fn + 2P : Increase brightness

3. Fn + 3P : Decrease brightness

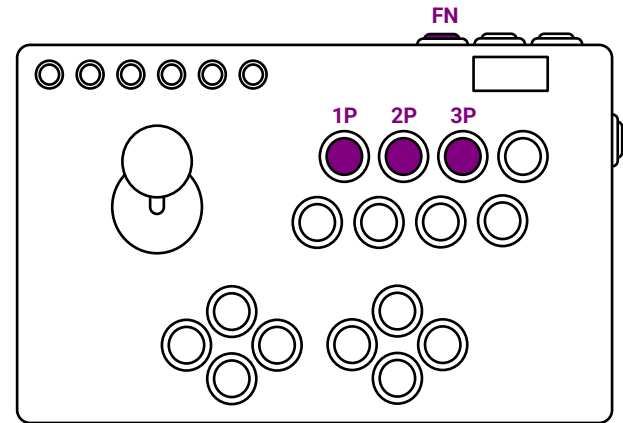

Supports RGB LED- Lighting Effect Description

1. All Off : RGB LEDs will not light up.
2. Turn off when pressed : Initially, the key LED is on. When pressed, the LED turns off. When the key is released, the LED turns on again.
3. Turn on when pressed : Initially, the key LED is off. When pressed, the LED turns on. When the key is released, the LED turns off again.
4. Breathing Light : The RGB LEDs gradually brighten and dim periodically.
5. Marquee(First to Last) : Colors will change in a gradient cycle from left to right according to the daisy-chained order of the RGB LEDs.
6. Marquee(Last to First) : Colors will change in a gradient cycle from right to left according to the daisy-chained order of the RGB LEDs.

Support Lock function

- Press and hold **【Fn + Option + Share】** to enable or disable the lock state.
The OLED screen will display a corresponding icon.
- When the lock state is enabled, the following buttons will be disabled : PS Key 、 Option 、 Share 、 Fn

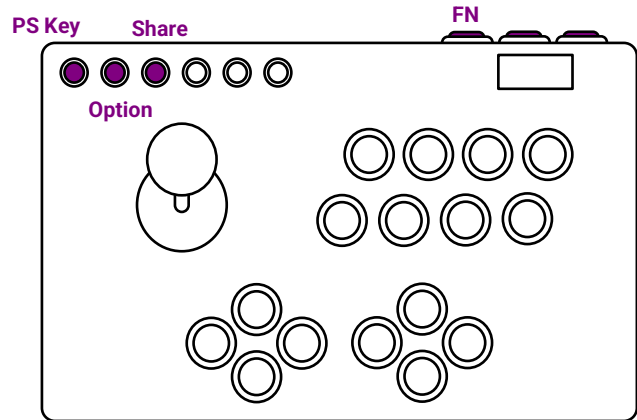

Gen-5X Series Fighting Board

Supports OLED- Display module

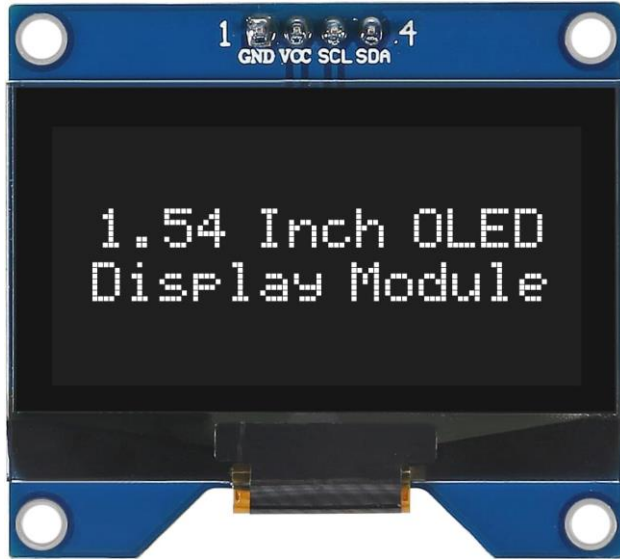

GND	Ground
VCC	3.3V~5V
SCL	Clock Line
SDA	Data Line
Resolution	128 x 64
Driver IC	SSD 1309, compatible with SSD1306
Interface	I2C Interface

Gen-5X Series Fighting Board

Supports OLED- Display Layout

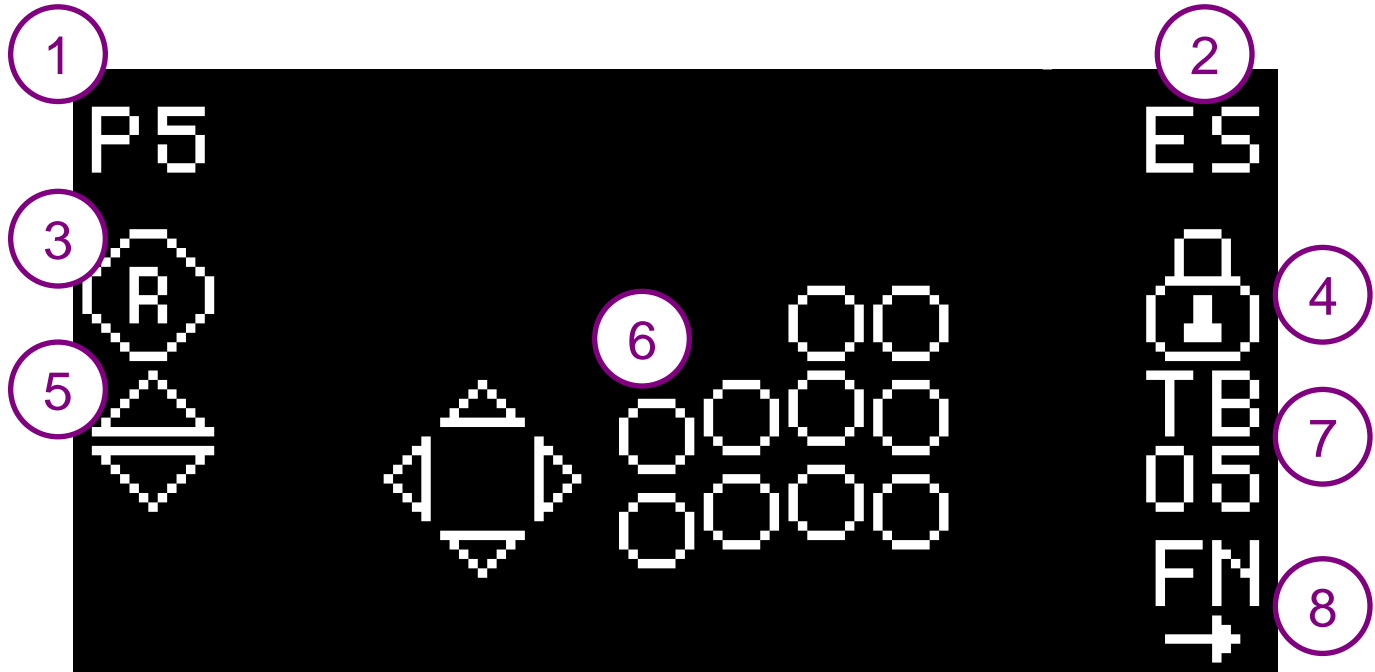

YOUR GAME.
OUR PLAY.



Breek

Supports OLED- Display instructions

1. Controller interface mode

Icon	Status/Item Name	Description
P5	Sony Playstation 5	The controller interface mode is : Sony Playstation 5
X5	Xbox Series X/S	The controller interface mode is : Xbox Series X/S
NS	Nintendo Switch	The controller interface mode is : Nintendo Switch
PC	PC (XID mode)	The controller interface mode is : PC (XID mode)

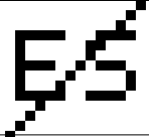

Supports OLED- Display instructions

2. Esport Mode : Indicates compliance with competition standards.

Icon	Status/Item Name	Description
	Compliant	Indicates that the current settings meet international esports standards.
	Non-compliant	Indicates that the current settings do not meet international esports standards, possibly due to Turbo and Macro functions being enabled.



Supports OLED- Display instructions

3. Stick mapping mode

Icon	Status/Item Name	Description
	DP mode (Default settings)	The current setting is DP mode.
	RS mode	The current setting is RS mode.
	LS mode	The current setting is LS mode.





Supports OLED- Display instructions

4. Lock Function States.

Icon	Status/Item Name	Description
	Unlocked.	The current status is unlocked.
	Locked.	The current status is locked.

Supports OLED- Display instructions

5. SOCD Mode

Icon	Status/Item Name	Description
	Up Priority (Default settings)	The current SOCD mode is Up Priority.
	All Neutral	The current SOCD mode is All Neutral.
	Last Priority	The current SOCD mode is Last Priority.
	ByPass	The current SOCD mode is ByPass.

Supports OLED- Display instructions

6. Button Configuration

There are two modes : "Normal Mode" and "Turbo Mode."

Normal Mode

When no buttons have Turbo mode enabled, display the current button press status in real-time.

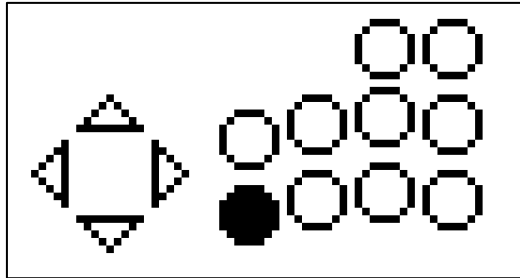

● : Represent buttons currently being pressed.

○ : Represent buttons currently not being pressed.

Turbo Mode

Display which buttons have Turbo mode turned on.

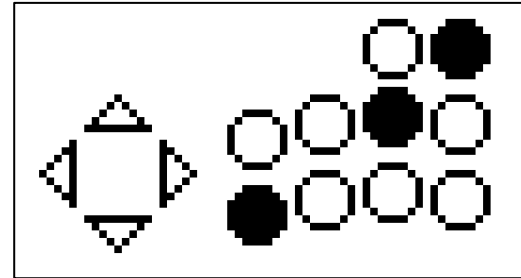

● : Buttons with Turbo mode

○ : Buttons without Turbo mode

Supports OLED- Display instructions

7. Turbo status

Icon	Status/Item Name	Description
NM	Normal Mode (Default settings)	The current setting is Normal Mode.
TB 05	Turbo Mode (5 Hit/Sec)	The current setting is Turbo Mode (5 Hit/Sec).
TB 10	Turbo Mode (10 Hit/Sec)	The current setting is Turbo Mode (10 Hit/Sec).
TB 15	Turbo Mode (15 Hit/Sec)	The current setting is Turbo Mode (15 Hit/Sec).
TB 20	Turbo Mode (20 Hit/Sec)	The current setting is Turbo Mode (20 Hit/Sec).
TB 25	Turbo Mode (25 Hit/Sec)	The current setting is Turbo Mode (25 Hit/Sec).

Supports OLED- Display instructions

8. Page Switch Hotkey Hint

Simply press **【FN + →】** to switch the OLED display to the next page and view the current firmware version.

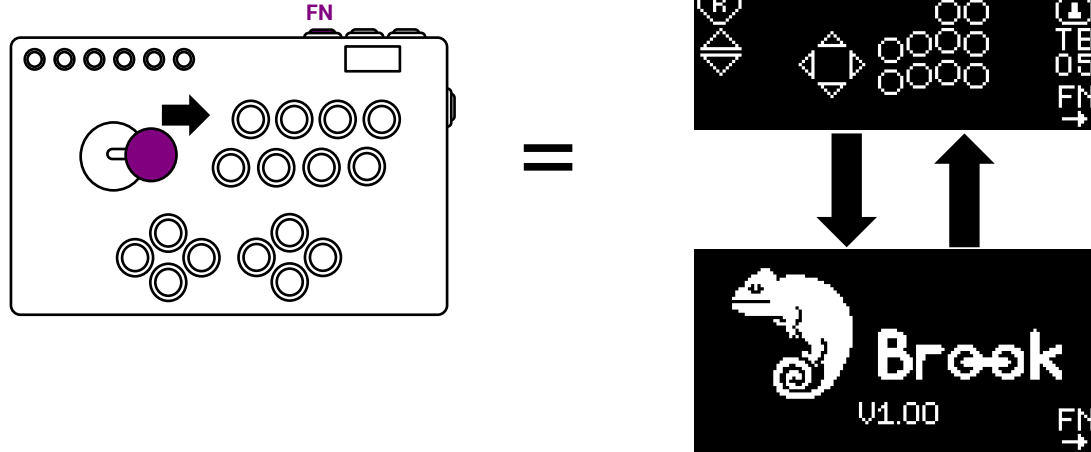

YOUR GAME.
OUR PLAY.



Gen-5X Series Fighting Board

FAQ

1. Can the Gen-5X Mini be used without connecting the Bluetooth module?
 - A. Yes, but you must first turn off the Bluetooth settings in the console for it to work properly.